

STANDARD(+), DUO(+), TOWER STANDARD/DUO/QUATTRO(+)

Simple & SMART wall-mounted and floor-mounted EV Charging Stations

USER MANUAL



INTRODUCTION

METRON wall-mounted STANDARD/DUO and floor-mounted TOWER STANDARD/DUO/QUATTRO are heavy duty all-metal modular EV charging stations designed for long life operation with maximum user safety features. They also offer smart charging via Metron proprietary Hardwired or Wireless Dynamic Power Control system, OCPP module with RFID reader for connecting to any cloud backend platform for payment and energy monitoring, ISO 15118 high level communication module for simple charging authorization and V2G capability, OTA software updates and more.

STANDARD models offer charging power up to 22 kW (3x32A) and DUO models offer charging power up to 2 x 22 kW and QUATTRO models offer charging power up to 4 x 22 kW. All models come with oversized main charging power contactor with 63A current rating for long life operation (20 years+), modular RCCB device (Type B or Type A with 6mA DC) with 10.000A short circuit breaking capacity and modular automatic circuit breaker with 10.000A short circuit breaking capacity what ensures not only safest domestic use but also allows the stations to be installed in industrial areas for commercial use. Modular design ensures on-site reparability in max. 15 minutes. The stations with built-in charging cables can also be equipped with TESLA remote charge port opener & plug unlocker.

Any other use is not allowed and is regarded as improper use.

Before using the EV charging station, please thoroughly read this manual and follow the instructions provided therein. Please keep the manual for future use. If you are unsure about the proper usage, please contact the manufacturer or your dealer before usage.

IMPROPER USE

Improper use can lead to property damage or personal injury. In such cases, the manufacturer and retailer accept no liability. Warranty will be voided in case of improper use. You must not:

- modify/manipulate the EV charging station!
- drive over plugs and cables of the EV charging station!
- draw more than maximum specified charging current from the EV charging station!
- connect unsuitable plugs and cables!
- use the EV charging station if damaged!





GENERAL SAFETY INSTRUCTIONS



- Carefully read this security instructions before using the product!
- Never draw more than maximum specified charging current from the EV charging station!
- Children are not allowed to use the EV charging station.
- Keep animals away while using the EV charging station.
- Avoid liquids entering the EV charging station. Never use the EV charging station if the sockets or plugs are wet.
- Only connect undamaged, designated and labelled plugs & cables to the EV charging station.

SYMBOLS USED

The following symbols are used in this manual and on the product:

	This symbol indicates a danger with a risk of causing serious injury or death or damage if not avoided.
	CE symbol is a mark of conformity indicating that a product complies with European Union directives and regulations.
	This symbol signifies the requirement for separate disposal of electrical and electronic waste. See chapter disposal.
	Please read the manual before using the EV charging station.
	Risk of electric shock due to dangerous voltage when used incorrectly.
T_{amb}	Do not use and store the EV charging station below or above the specified temperature.

GET STARTED



- Check the EV charging station before use. Do not use the EV charging station if damaged!
- Socket will provide a high voltage [230/400 V]!
- Never draw more than maximum specified charging current from the EV charging station!
- Do not use the EV charging station if the socket and plug are wet.
- Only connect undamaged, designated and labelled plugs & cables to the EV charging station.
- Avoid using multiple adapter/power strips as they can lead to overload.
- Don't unplug during charging process.
- Always operate in the specified order of steps.

When no electric vehicle is connected the blue LED STATUS O-ring around station's black push button[s] glows constantly indicating standby/ready status. When you plug in the vehicle the STATUS LED O-ring starts blinking slowly what means the vehicle is charging. When your electric vehicle is fully charged the LED O-ring glows constantly again.

If hardwired or wireless Metron Dynamic Power Control system that offers smart charging is installed the charging power is dynamically controlled in order to not blow main house fuses and not surpass the grid power draw limit agreed with grid operator/electricity supplier; this system is also smartly taking into account the solar/wind/hydro power plant if house has it installed [see chapter "METRON Hardwired or Wireless Dynamic Power Control" for more info]. Users can also via WiFi connect to built-in Metron Charge Control application which offers possibility to change charging power, delay charging start, monitor real-time charging&house&solar power & energy, activate solar SURPLUS charging and much more [see chapter "USING THE WIFI METRON Charge Control application" for more info].

If the station is configured in the way authorization is needed for charging start the STATUS LED O-ring shortly blinks every 2 seconds but after successful authorization (RFID, AutoCharge, OCPP backend, Metron Charge Control app, etc) the STATUS LED O-ring behaves normally.

SETTING THE DESIRED CHARGING CURRENT / POWER without WiFi connection

METRON EV charging stations allow users to set desired charging current/power before being plugged in the electric vehicle. Procedure is simple:

- Press and hold the push button: blue STATUS LED O-ring switches off immediately.
- After 5 seconds blue STATUS LED O-ring starts blinking slowly.
- Releasing the push button after a certain number of blue LED O-ring blinks determines charging current/power as follows:

Applies to all station versions!

Number of LED blinks	Charging current/power	
	1 - phase stations	3 - phase stations
1	1 x 6 A / 1,4 kW	3 x 6 A / 4,1 kW
2	1 x 8 A / 1,8 kW	3 x 8 A / 5,5 kW
3	1 x 10 A / 2,3 kW	3 x 10 A / 6,9 kW
4	1 x 13 A / 3,0 kW	3 x 13 A / 9,0 kW
5	1 x 16 A / 3,7 kW	3 x 16 A / 11,0 kW
6*	1 x 20 A / 4,6 kW	3 x 20 A / 13,9 kW
7*	1 x 25 A / 5,8 kW	3 x 25 A / 17,3 kW
8*	1 x 32 A / 7,4 kW	3 x 32 A / 22,0 kW

* 1-phase 7,4 kW and 3-phase 22 kW stations only.

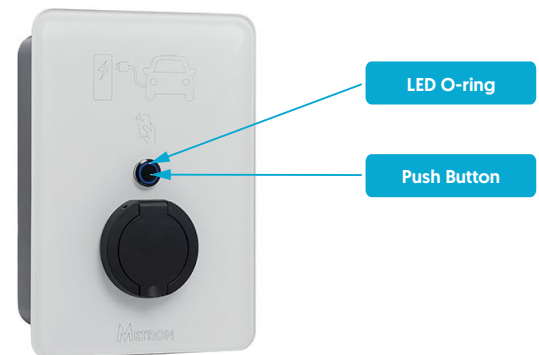

New charging current/power setting is stored in the memory and it stays the same (even after the power supply is not present anymore) until the next setting change is performed.

REMOTE CHARGE PORT OPEN & PLUG UNLOCK for TESLA electric vehicles

Metron charging stations with built-in charging cables can be equipped with TESLA remote charge port open & plug unlock electronics. Pressing a “2-function” button on the vehicle Type 2 plug sends a remote-control signal to your TESLA vehicle charge port which then opens. Signal range is usually between 3 and 15 meters. This feature eliminates user “touching” the smart phone or Tesla central screen in order to open the charge port. Remote-control signal also wakes-up the Tesla vehicle from sleep - sometimes the button needs to be pressed several times to wake-up the vehicle.

To unplug while still charging or when charging completed press and hold the “2-function” button for a second. The car will unlock the vehicle plug (only if car is unlocked/owner nearby!) and then you can unplug it. Plug unlock function works even if the charging station is not powered (manually turned off, grid power outage, etc).

This feature once again eliminates the need for user “touching” the smart phone or Tesla central screen in order to unlock the charging plug from Tesla charge port.



USING THE WiFi METRON Charge Control application (SMART »+« charging stations only)

Smart EV charging stations marked with “+” have a built-in WiFi access point with web server what enables users to connect to it wirelessly by any smart phone, tablet or laptop PC. As there is a web server inside with preloaded METRON Charge Control application you don't need to install any additional program/application on your device because the METRON Charge Control simply runs in your favorite web browser (Google Chrome, Microsoft Edge, Mozilla Firefox...) on any operating system (Google Android, Apple iOS, Microsoft Windows, Huawei HarmonyOS, Linux...) you have on your smart phone, tablet or laptop PC.

Using the web-based METRON Charge Control application user can:

- Set the desired charging current, delay charging start, limit the allowed charging energy, set the daily scheduled charging.
- Set the daily Smart Scheduled Charging timer with desired grid power draw limits for each hour of the day.
- Turn on/off solar SURPLUS charging if solar power plant is installed.
- Switch between 1-phase and 3-phase charging (optionally).
- See real time measurements of charging power, charging current and charging energy.
- Change WiFi password and WiFi name (ssid).
- Connect the charging station to local WiFi network and also set the charging station internet access in the WiFi router (advanced users).
- OTA (over-the-air) install UPDATES for application firmware via WiFi.
- If METRON Dynamic EV Charging Unit for SMART charging with house main fuse protection and grid power draw limit function is installed the user can also see house load, house energy consumption, solar power and solar energy production.
- Establish station internet connection via OCPP protocol to backend systems (Metron or others) for station control, payment for charging, energy monitoring, etc via internet (OCPP module needed)
- Locally authorize RFID cards (OCPP module needed)
- Locally authorize electric vehicles via supported AutoCharge function (ISO 15118 module and OCPP module needed)

To connect to the WiFi METRON Charge Control application you need to do the following:

- Make sure the charging station is energized (connected to power).
- Go to WiFi menu in your smart phone, tablet or laptop PC and search for WiFi networks.
- Find “METRON Station 1” (default) network and connect to it; enter the WiFi password 12345678 (this is default - it is recommended that you change it in the METRON Charge Control application).
- Scan QR code you find on the station and follow the link (it will open your default web browser and launch the Metron Charge Control automatically); OR open your favorite web browser and type in the following IP address: <http://192.168.4.4>
- The METRON Charge Control application will be loaded immediately. Up to 5 users (devices) at a time can be wirelessly connected to the station and all connected devices will automatically receive all the latest data; for example, if one user changes the charging current with the slider all others will see that on their screens.

If you forget the WiFi password you've set, you need to do the following:

- Disconnect the station from power, press the “Push Button” and keep it pressed.
- Connect the station to power.
- The blue STATUS LED O-ring starts blinking 2 times.
- After 30 seconds the blue STATUS LED O-ring will turn-on for 3 seconds and then turn-off.
- Release the “Push Button” and WiFi name (ssid) & password are reset to default values.

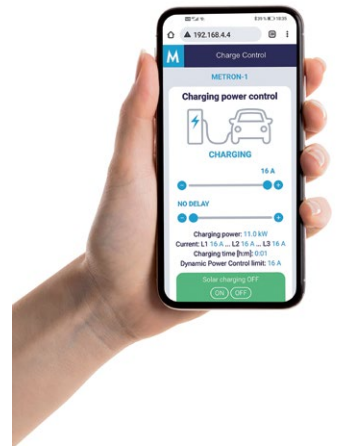

The METRON Charge Control application is intuitive and usually doesn't need more instructions to be used; just browse and explore the functions. Where the additional user info is required important user instructions are explained under “notes”. If you don't understand something please feel free to contact Metron.

METRON Hardwired and Wireless Dynamic Power Control (SMART »+« charging stations only)

Smart “+” marked EV charging stations can be equipped with Hardwired [1 station per main fuse] or Wireless Dynamic Power Control system [up to 150 charging stations per main fuse] that is always monitoring the load at house main fuse with electric current sensors and dynamically adjusting [lowering or rising] the charging current/power of your electric vehicle in the way the main house fuse never gets overloaded [never blows-up] and grid power draw limit is not exceeded. If the house has a solar [or wind/hydro] power plant installed this system allows higher current/power charging than would be allowed by the main fuse and it also enables the possibility of user activated solar SURPLUS charging what means the vehicle will be charged only with excess solar power without taking any energy from the grid. METRON Wireless Dynamic Power Control system is designed to work with 1-phase and 3-phase power systems. To be short, METRON Dynamic Power Control system enables users to charge their electric vehicle without worrying about the load other household appliances might draw from the in-house grid.

For 1-station Hardwired Dynamic Power Control the installer needs only to place clamp-on current sensors to main house power inlet and solar power plant (if present). In case of dynamically controlling 2 or more charging stations this can be done wirelessly only as this greatly reduces laying cables and thus cost. For METRON Wireless Dynamic Power Control all you need is 1 pcs METRON Dynamic EV Charging Unit (models 3FD-3 & 3FD-3.1) with clamp-on current sensors. This way up to 150 Metron wall-mounted, floor mounted or even METRON smart portable EV charging stations can be controlled; main fuses with rated currents up to 1000A and grid power draw limit up to 700 kW are supported.

Note: Wireless signal has an open-air space range of 500m with built-in antenna and up to 2000m with additional antennas on the METRON Dynamic EV Charging Unit (models 3FD-3 & 3FD-3.1). If the system is installed within one house usually no additional antenna is needed.

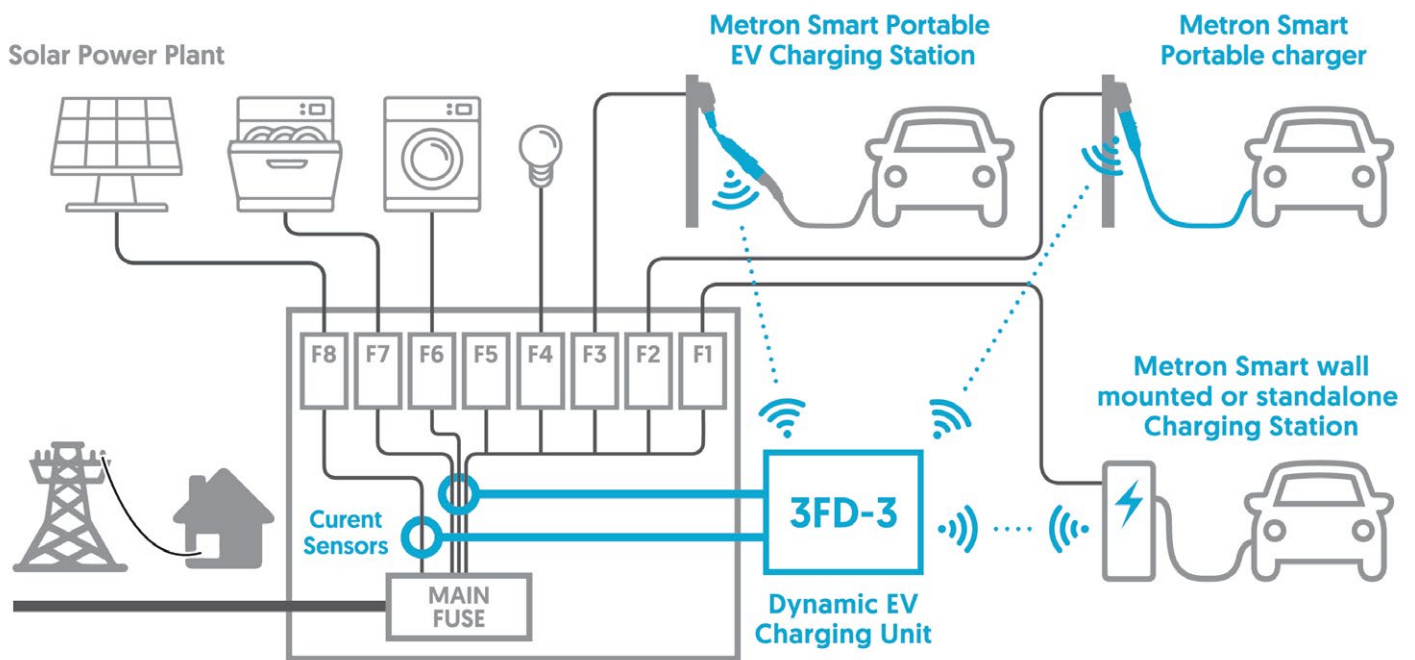

Detailed schematics for installing METRON Dynamic Power Control system are located in a separate installation manual, intended for qualified installers only.

STATUS NOTIFICATION BY LED O-ring

STATUS LED O-ring state

NOTIFICATION

Blue LED blinking slowly when power supply is applied	Indicating previous saved current setting
Blue LED constantly ON when not plugged in	Stand-by/Ready to charge
Blue LED blinking slowly when plugged in	Charging
Blue LED constantly ON when plugged in	Electric vehicle fully charged
Blue LED blinking slowly 2 times when plugged in	Electric vehicle requests room ventilation (no charging)
Blue LED blinking slowly 4 times (plugged in or not plugged in)	Charging temporary terminated by Dynamic Power Control system, no wireless RF signal from METRON Dynamic EV Charging Unit or charging terminated by the user
Purple and red LED blinking 4 times (newer versions)	No wireless RF signal from METRON Dynamic EV Charging Unit
Blue LED blinking slowly 9 times	Charging terminated due to overcurrent (unplug to reset, vehicle service may be needed)
Blue LED blinking fast (plugged in or not plugged in)	Station or vehicle fault

TECHNICAL SPECIFICATIONS

STANDARD(+) & TOWER STANDARD(+)

DUO(+) & TOWER DUO(+) & TOWER QUATTRO(+)

Charging station plug/socket type	Type 2 / Type 1 (IEC 62196 / SAE J1772) female plug or Type 2 Female charging socket	Type 2 / Type 1 (IEC 62196 / SAE J1772) female plug or Type 2 Female charging socket
Max. charging power	3,7 kW or 7,4 kW (1-phase) 11 kW or 22 W (3-phase)	2* x 3,7 kW or 2* x 7,4 kW (1-phase), 2* x 11 kW or 2* x 22 kW (3-phase); [*4 instead of 2 for QUATTRO models]
Max. charging current	16 A or 32 A (1-phase), 3x16 A or 3x32 A (3-phase)	2* x 16 A or 2* x 32 A (1-phase), 2* x 3x16 A or 2* x 3x32 A (3-phase); [*4 instead of 2 for QUATTRO models]
Possible charging current settings (by user)	6/8/10/13/16/20**/25**/ 32**A via front button, "+" models from 6A in 1A steps to 16A or 32A via WiFi Metron Charge Control app. ** 32 A rated stations only	6/8/10/13/16/20**/25**/ 32**A via front button, "+" models from 6A in 1A steps to 16A or 32A via WiFi Metron Charge Control app. (for each socket/plug independently) ** 32 A rated stations only
Rated Voltage	230 Vac (1-phase), 400 Vac (3-phase)	230 Vac (1-phase), 400 Vac (3-phase)
Operating voltage / frequency	from 180 V up to 270 V (phase voltage) / 50 Hz	from 180 V up to 270 V (phase voltage) / 50 Hz
Overvoltage category	III (IEC/EN 60664)	III (IEC/EN 60664)
Power consumption	5 W	10 W (DUO), 20 W (QUATTRO)
Charging cable (applicable for stations with cable and charging plug)	Straight (any length) or SPIRAL Black or Orange color Premium quality according to EV charge cable standard EN 50620	Straight (any length) or SPIRAL Black or Orange color Premium quality according to EV charge cable standard EN 50620
Type 2 or Type 1 plug holder	optional for all models with charging cable	optional for all models with charging cable
Tesla remote for opening charge port and unlocking the plug – integrated in Type 2 plug	optional for all models with Type 2 plug	optional for all models with Type 2 plug
Locking mechanism for Type 2 charging socket	optional for all models with Type 2 socket	optional for all models with Type 2 socket
Main charging contactor rated current-carrying capacity	63 A (all models without exceptions to ensure safe and long-lasting operation)	63 A (all models without exceptions to ensure safe and long-lasting operation)
Overcurrent protection	1 x circuit breaker C20A or C40A for charging + 1 x circuit breaker C2A for electronics; 10.000 A short circuit breaking capacity	2* x circuit breaker C20A or C40A for charging + 2* x circuit breaker C2A for electronics; 10.000 A short circuit breaking capacity; [*4 instead of 2 for QUATTRO models]
Additional independent numerical (software) overcurrent protection (acts on charging contactor)	YES, Smart "+" models only	YES, Smart "+" models only
Differential protection - Residual Current Circuit Breaker (RCCB)	1 x Type B or Type A 30 mA AC with 6mA DC; 10.000 A short circuit breaking capacity	2* x Type B or Type A 30 mA AC with 6mA DC; 10.000 A short circuit breaking capacity; [*4 instead of 2 for QUATTRO models]
MID certified Energy meter	optional for all models	optional for all models
METRON proprietary Hardwired or Wireless Dynamic Power Control system	YES, Smart "+" models only	YES, Smart "+" models only
Switching between 1-phase and 3-phase charging	optional for Smart "+" models only	optional for Smart "+" models only
OCPP 1.6J module with integrated WiFi and Ethernet internet connectivity for remote monitoring and payment, also supports OCPP load management	optional for Smart "+" models only	optional for Smart "+" models only
RFID reader for ISO/IEC 14443A compatible MIFARE cards/tags, internal storage for 100 cards with energy meter for each card	optional for Smart "+" models only	optional for Smart "+" models only
ISO 15118 High-level communication module with AutoCharge and future V2G capability, internal storage for 100 vehicles with energy meter for each vehicle [AutoCharge]	optional for Smart "+" models only	optional for Smart "+" models only
LED display (resistant to high temperatures and direct solar irradiation)	optional for Smart "+" models only	optional for Smart "+" models only
4G/5G Router	optional for Smart "+" models only	optional for Smart "+" models only
Network/ethernet switch	optional for Smart "+" models only	optional for Smart "+" models only
Analog input for controlling charging current/power (0-5V or 0-10V or 0-20mA)	YES, all models	YES, all models
Digital input for charging authorization/activation by external device	YES, all models	YES, all models
WiFi Metron Charge Control app. (web based)	YES, Smart "+" models only	YES, Smart "+" models only
Supported WiFi standards	IEEE 802.11b/g/n (Smart "+" models only)	IEEE 802.11b/g/n (Smart "+" models only)
WiFi speed	up to 150 Mbit/s (Smart "+" models only)	up to 150 Mbit/s (Smart "+" models only)
WiFi security	WPA2 (Smart "+" models only)	WPA2 (Smart "+" models only)
WiFi signal range	up to 20 m (Smart "+" models only)	up to 20 m (Smart "+" models only)

STANDARD(+) & TOWER STANDARD(+)

DUO(+) & TOWER DUO(+) & TOWER QUATTRO(+)

Enclosure material	STANDARD(+): 2-3mm thick steel + ultra clear tempered glass with white ceramic back coat TOWER STANDARD(+): 1.5mm thick stainless steel + ultra clear tempered glass with white ceramic back coat	DUO(+): 2-3mm thick steel + ultra clear tempered glass with white ceramic back coat TOWER DUO & QUATTRO(+): 1.5mm thick stainless steel + ultra clear tempered glass with white ceramic back coat
Paint/anti-corrosion protection	Structural powder coat	Structural powder coat
Color	Anthracite grey, other colors on request	Anthracite grey, other colors on request
UV resistance	Yes [all parts]	Yes [all parts]
Operating ambient air temperature range	from -30°C to +50°C	from -30°C to +50°C
Storage temperature	from -40 °C to +70 °C	from -40 °C to +70 °C
Maximum operating altitude	2000 m	2000 m
Relative ambient humidity (operation and storage)	max 95 % (without condensation)	max 95 % (without condensation)
IP Rating	IP54 (rain proof)	IP54 (rain proof)
IK Rating	IK10 (impact/shock proof)	IK10 (impact/shock proof)
Access for maintenance and repair	Door with key lock	Door with key lock
Minimum required power supply cable cross section (copper)	3G2,5 mm2 for 3,7 kW 3G6 mm2 for 7,4 kW 5G2,5 mm2 for 11 kW 5G6 mm2 for 22 kW	3G6 mm2 for 2 x 3,7 kW 3G16 mm2 for 2 x 7,4 kW 5G6 mm2 for 2 x 11 kW 5G16 mm2 for 2 x 22 kW 5G35 mm2 for 4 x 22 kW
Dimensions (HxWxD)	STANDARD(+): 340 x 240 x 100 mm TOWER STANDARD(+): 1400 x 200 x 150 mm	DUO(+): 500 x 370 x 100 mm TOWER DUO(+) & QUATTRO(+): 1400 x 300 x 200 mm
Weight	STANDARD(+): Approx. 8-10 kg TOWER STANDARD(+): Approx. 20-22 kg	DUO(+): Approx. 16-20 kg TOWER DUO(+): Approx. 30-34 kg TOWER QUATTRO(+): Approx. 34-38 kg

WHAT IS RCCB AND HOW DOES IT WORK?

RCCB is an acronym for Residual Current Circuit Breaker - sometimes it can be called also Earth Leakage Circuit Breaker or Safety Switch. Its purpose is to prevent you from getting a fatal electric shock if you touch live part, such as a bare copper wire under high voltage. RCCBs offer a level of personal protection that ordinary fuses/-circuit-breakers cannot provide. RCCB constantly monitors the electric current flowing through one or more circuits which it protects. If it detects electricity flowing down an unintended path, such as through a person who has touched a live part, the RCCB will switch the circuit off very quickly, significantly reducing the risk of death or serious injury. Every charging station has integrated Type A 30mA AC + 6mA DC or Type B RCCB what ensures maximum possible level of personal protection as it protects users from AC, pulsating DC and pure DC leakage currents.

CLEANING

Use only a dry or damp cloth for cleaning the switched off EV charging station. Do not use cleaning detergents.



- EV charging station must be switched off before cleaning!
- Avoid water getting to contact parts!

DISPOSAL



The symbol "crossed-out trash can" signifies the requirement for separate disposal of electrical and electronic waste. These devices may contain hazardous and environmentally harmful substances. Please take such devices to a designated collection point for the recycling of electrical and electronic equipment and do not dispose of them in regular household waste. You can obtain further information from local waste disposal services or the company from which you purchased the product.

GREEN PRODUCTION

All our products are produced in a carbon neutral way by using "Sustainable energy cycle" method. Production plant where we make charging cables and portable charging stations is the first fully sustainable production facility for EV charging cables. All energy needed for the heating and cooling of the building, production process and for transportation of goods and employees (except deliveries of heavy materials by trucks), is produced by 2 photovoltaic power plants and stored in 4 storage batteries. Almost all of the raw materials we use (cables, plugs) are produced in EU, to shorten supply routes and support local economy. [Buying our products helps developing sustainable economy.](#)

LIMITED WARRANTY

METRON warrants its product to the original consumer purchaser that it will repair, or replace, any product that is determined to be defective for the following terms: **Two (2) years from date of purchase on all components.** To be eligible for repair or replacement under this warranty, the product in question must be sent back to METRON within the warranty period and the original consumer purchaser must comply with the following conditions: The product thereof must not have been modified or altered in any way by an unauthorized source; The product thereof must have been used in accordance with the user manual. This limited warranty does not cover: Damage due to improper use; Accidental or intentional damage; Misuse, abuse, corrosion, or neglect; Product impaired by severe natural conditions, such as excessive hail storms, lightning strikes, tornados, flooding, ice or other natural occurrences; Damage due to improper packaging on return shipment. Any and all labor charges for troubleshooting, removal or replacement of the product are not covered by this warranty and will not be honored by METRON. All shipping costs regarding repair or replacement of the product is to be pre-paid by the original consumer purchaser.